

Plummer Blocks

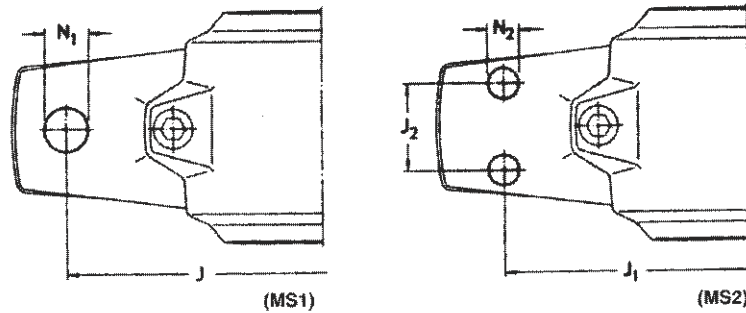

SSNAD-SERIES PLUMMER BLOCKS WITH DRILLED HOLES IN BASE

HOUSING DESIGNATION	DIMENSION FOR TWO HOLE BASE (MS1)		SUITABLE BOLT SIZE	DIMENSION FOR FOUR HOLE BASE (MS2)			SUITABLE BOLT SIZE
	J	N1		J1	J2	N2	
SSNAD 511-609	210	18	M 16	200	35	13	M 12
SSNAD 512-610	210	18	M 16	200	35	13	M 12
SSNAD 513-611	230	18	M 16	220	40	13	M 12
SSNAD 515-612	230	18	M 16	220	40	13	M 12
SSNAD 516-613	260	22	M 20	250	50	13	M 12
SSNAD 517	260	22	M 20	250	50	13	M 12
SSNAD 518-615	290	22	M 20	280	50	18	M 16
SSNAD 519-616	290	22	M 20	280	50	18	M 16
SSNAD 520-617	320	26	M 24	300	60	18	M 16
SSNAD 522-619	350	26	M 24	320	70	18	M 16
SSNAD 524-620	350	26	M 24	330	70	18	M 16
SSNAD 526	380	28	M 24	370	70	22	M 20
SSNAD 528	420	35	M 30	400	80	26	M 24
SSNAD 530	450	35	M 30	430	90	26	M 24
SSNAD 532	470	35	M 30	450	90	26	M 24

All other principal dimensions remain identical to SNA Series Plummer Blocks.

SEALING ARRANGEMENTS (AVAILABLE AS SPARE ACCESSORIES ALSO)

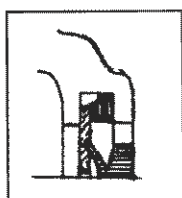

Type - A unsplit
TSNA...A
(2V-Ring Seals)

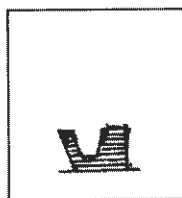

Type - V unsplit
V.....A
(Separate V-Ring only)

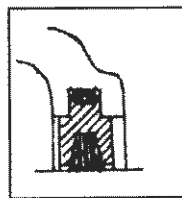

Type - C split
TSNA...C
(2 Felt Seals)

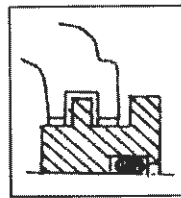

Type - S unsplit
TSNA...S
(2 Labyrinth Collars with rubber o' Cords)

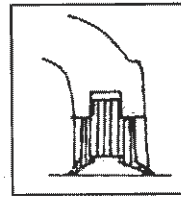

Type - G split
TSNA...G
(2 Double Lip Seals)

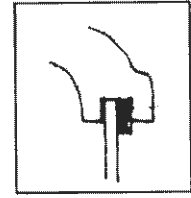

End Cover ASNA...
(1-Endcover)

ALL PLUMMER BLOCKS OF SN SERIES ARE FLOATING BEARING HOUSINGS WHICH CAN BE MADE LOCATING BY FITTING SUITABLE LOCATING RING/S IN THE HOUSING

Plummer Blocks SSNHD & SSNLD

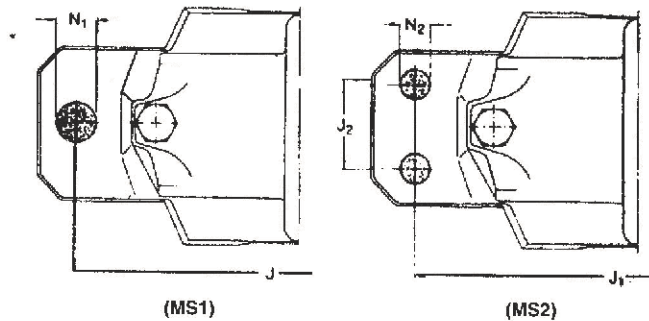

**SSNHD-SERIES PLUMMER BLOCKS WITH DRILLED HOLES IN BASE
SAME TO SSNHD / SSNLD**

HOUSING DESIGNATION	DIMENSION FOR TWO HOLE BASE (MS1)		SUITABLE BOLT SIZE	DIMENSION FOR FOUR HOLE BASE (MS2)			SUITABLE BOLT SIZE
	J	N1		J1	J2	N2	
SSNHD 508-607	170	15	M 12	160	34	11	M 10
SSNHD 509	170	15	M 12	160	34	11	M 10
SSNHD 510-608	170	15	M 12	160	34	11	M 10
SSNHD 511-609	210	18	M 16	200	40	14	M 12
SSNHD 512-610	210	18	M 16	200	40	14	M 12
SSNHD 513-611	230	18	M 16	220	48	14	M 12
SSNHD 515-612	230	18	M 16	220	48	14	M 12
SSNHD 516-613	260	22	M 20	252	52	18	M 16
SSNHD 517	260	22	M 20	252	52	18	M 16
SSNHD 518-615	290	22	M 20	280	58	18	M 16
SSNHD 519-616	290	22	M 20	280	58	18	M 16
SSNHD 520-617	320	26	M 24	300	66	18	M 16
SSNHD 522-619	350	26	M 24	320	74	18	M 16
SSNHD 524-620	350	26	M 24	330	74	18	M 16
SSNHD 526	380	28	M 24	370	80	22	M 20
SSNHD 528	420	35	M 30	400	92	26	M 24
SSNHD 530	450	35	M 30	430	100	26	M 24
SSNHD 532	470	35	M 30	450	100	26	M 24

Note : All other principal dimensions of SSNHD/SSNLD housings are identical to SNH & SNL housings

HOUSING FOR THROUGH SHAFT BOTH ENDS OPEN

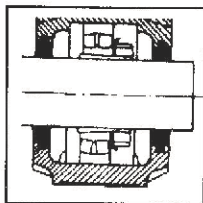

Housing with Felt Seals : Type TC

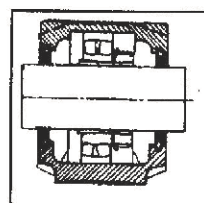

Housing with two V Ring : Type TA

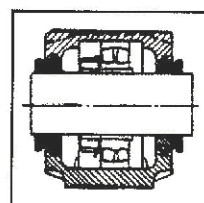

Housing with two labyrinth Seals : Type TS

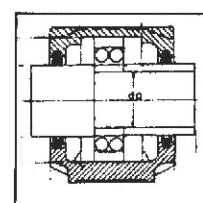

Housing with double Lip-Seals : Type TG

HOUSING FOR END SHAFT ONE END CLOSED

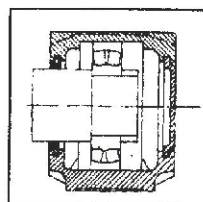

One End Cover & One V Ring Seals : Type ATA

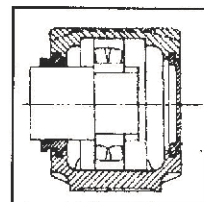

One End Cover & One Lady Seals : Type ATS

Happiness is a positive cash flow